

CPU-XL VariSpark ADVANCED DIGITAL IGNITION SYSTEM FOR LARGE GAS ENGINES

- State-of-the-art, crankshaft-referenced digital ignition system for natural-gas fueled integral compressor engines
- Innovative and patented (U.S. Patent 7,401,603) Directed Energy spark control capability optimizes performance on emissions-controlled engines as well as on applications experiencing wide variations in operating and ambient conditions
- Incorporates an engine-specific ignition coil/EZRail system rail for cost-effective installation and operation
- Comprehensive system and spark discharge diagnostics help to insure the swift identification of operating issues and to minimize associated engine downtime
- Spark discharge diagnostics indicate the required breakdown voltage in kV, enabling operators to better understand in-cylinder conditions
- System timing, spark profile, and access to all other system options and diagnostics are available from the system keypad and graphical display, as well as remotely via Modbus RTU communications

The Altronic CPU-XL VariSpark is a 24-VDC-powered digital ignition system for large gas engines and integral compressors. It combines the reliability and operating simplicity of first- and second-generation ignition systems such as the II-CPU and CPU-2000, with Altronic's newly-patented spark control capability and system diagnostics.

Combustion assurance across a wide range of operating and in-cylinder conditions is the goal of the CPU-XL system. The CPU-XL system stretches the envelope of successful operation, allowing combustion to take place under difficult circumstances, such as operating near the lean misfire limit for emissions, under lighter loads, or on engines that mix the air/fuel charge poorly. This is possible through the introduction of a controllable, selectable spark profile, optimized for those conditions, a Directed Energy spark. By choosing one of eight waveforms, including several which can deliver secondary current levels as much as twenty times that of a conventional capacitive discharge spark, the secondary voltage and current delivered to the spark plug and air/fuel mixture can be matched—and dynamically adjusted—to meet the operating requirements and conditions of the engine, thus assuring combustion. Supported by Altronic's discharge diagnostics, the CPU-XL VariSpark system delivers an unparalleled combination of features and capabilities.

To insure a high level of convenience and a minimum level of new product training, the operating philosophy and functionality is very similar to other Altronic digital ignitions, including the CPU-2000. The CPU-XL VariSpark incorporates modular system construction, including standard system harnesses with a unique ignition coil/EZRail combination. The availability of all of these components as purchased parts limits on-engine fabrication and allows for simpler system troubleshooting.

Combustion Assurance for:

- IMPROVED FUEL PERFORMANCE
- IMPROVED EMISSIONS
- IMPROVED RELIABILITY

 CERTIFIED CLASS
I, DIVISION 2,
US GROUPS C & D



The Directed Energy Difference: Moving Beyond Conventional CD Ignition Technology

The capacity of a conventional capacitive-discharge (CD) ignition system to deliver voltage and current to the spark plug and air/fuel mixture has traditionally been governed by the design of the ignition system and the associated ignition coil (transformer). The standard CD ignition system uses a capacitor charged to full voltage. When triggered, it is fully discharged during each spark event. This spark is characterized by a peak of both voltage and current during the breakdown phase with both declining through the ionization, duration, and ring-down phases.

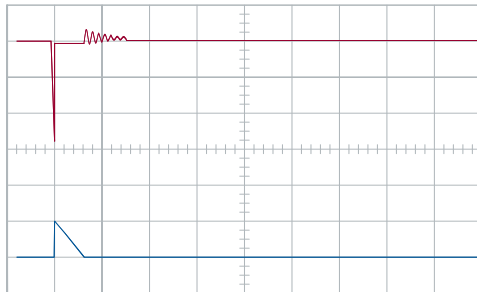

Diagram A
V = VOLTAGE
I = CURRENT

Diagram A depicts a conventional CD spark breakdown event. A duration of approximately 300µsec is determined largely by the coil characteristics. The energy in the ring-out pattern following the breakdown phase represents lost energy. If additional energy is supplied from the ignition driver in the form of a higher primary voltage, some additional duration is achieved but the conversion efficiency is increasingly lower.

A Directed Energy System takes a different approach. Instead of fully discharging the (very large) capacitor, a measured amount of current and voltage is discharged into the ignition coil/spark plug during each spark event. This allows for a specified, pre-fabricated spark profile—inclusive of both delivered voltage and current, as well as multiple strikes. The result: delivered energy (voltage, current, and number of strikes) to the air/fuel mixture in the cylinder that assures combustion.

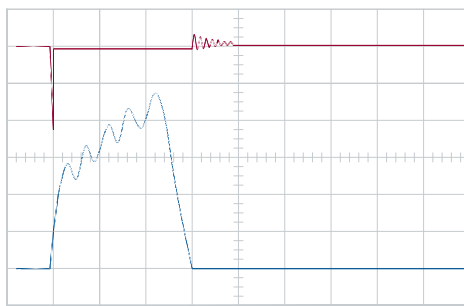

Diagram B
V = VOLTAGE
I = CURRENT

Diagram B illustrates that the rules associated with a CD spark no longer apply with a Directed Energy System—including the traditional peak of current registered during the breakdown phase and a general decline in the delivered current through the duration portion of the spark event. Through a modulation of the applied spark energy, the realizable spark voltage can reach 50,000 volts and the delivered energy per spark event can reach as high as twenty times that provided in a conventional spark. The concept of “shaping the spark” to dynamically optimize the performance of the engine and to provide **Combustion Assurance** for fuel economy, emissions, and operating reliability is a reality. Multiple strikes of varying duration, single strikes with escalating current, long duration single strikes and combinations of all of the above are made possible by the Directed Energy technology.

How a Directed Energy Ignition System impacts the operation of your engine

A directed energy ignition system is a misfire reduction tool designed and manufactured to assure combustion under difficult engine operating and ambient conditions. Eliminating misfire as a means of meeting any number of operating goals is the key to the technology and represents the core operating benefit of the CPU-XL Varispark system.

- **The CPU-XL Varispark plays a critical role in optimizing an emissions control strategy.** Operating alone in an open-chamber lean-burn environment (or in concert with other misfire reduction technologies such as pre-combustion chambers, high pressure fuel injection, port fuel injection, etc.), a controlled, high-energy spark or multi-spark event extends the lean misfire limit significantly and assures the user of reliable operation even under strict environmental permitting requirements.

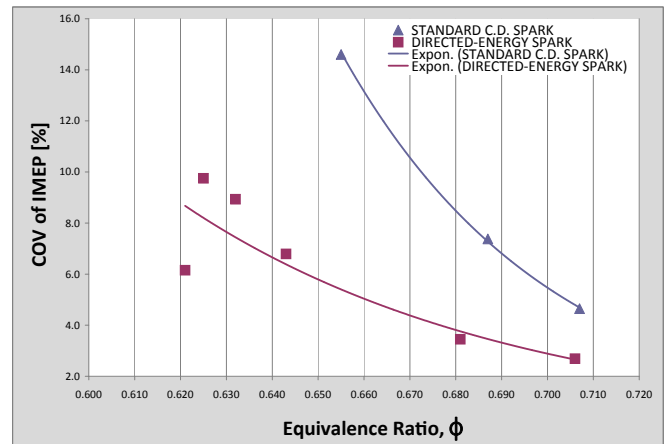

The diagram above demonstrates the combustion stability made possible by a directed energy spark profile (extended duration with increasing current). Note that the COV of IMEP (the percent of misfire) for the long duration, high-current directed energy spark is consistently lower across the equivalence ratio (equivalence ratio = $\frac{1}{\lambda}$) than the conventional CD spark, thus driving the lean misfire rate and expanding the envelope of reliable operation. (Source: *Combustion Performance Test on a Cooper GMV Engine: Altronic DEIS vs. CPU-2000*, Prometheus Applied Technologies, LLC, 2011)

- **The CPU-XL Varispark delivers improved fuel consumption performance.** A high-current and/or multi-strike directed energy spark delivers misfire reduction and the associated reduction in brake specific fuel consumption at heavy loads and high boost pressures. Selection of one of the pumped current spark profiles has also demonstrated particular success in addressing light-load-related misfire/fuel requirements in both open-chamber and pre-combustion chamber equipped applications.
- **Lower misfire = more reliable, smoother operation.** As noted above, the directed energy spark technology within the CPU-XL Varispark reduces engine misfire. While positively impacting engine emissions and fuel consumption, the system also provides the associated benefits of enhanced stability and reliability in engine operation, as well as reduced mechanical stresses on the engine—particularly related to misfire-induced engine detonation (knock).

CPU-XL VariSpark System Description and Operation

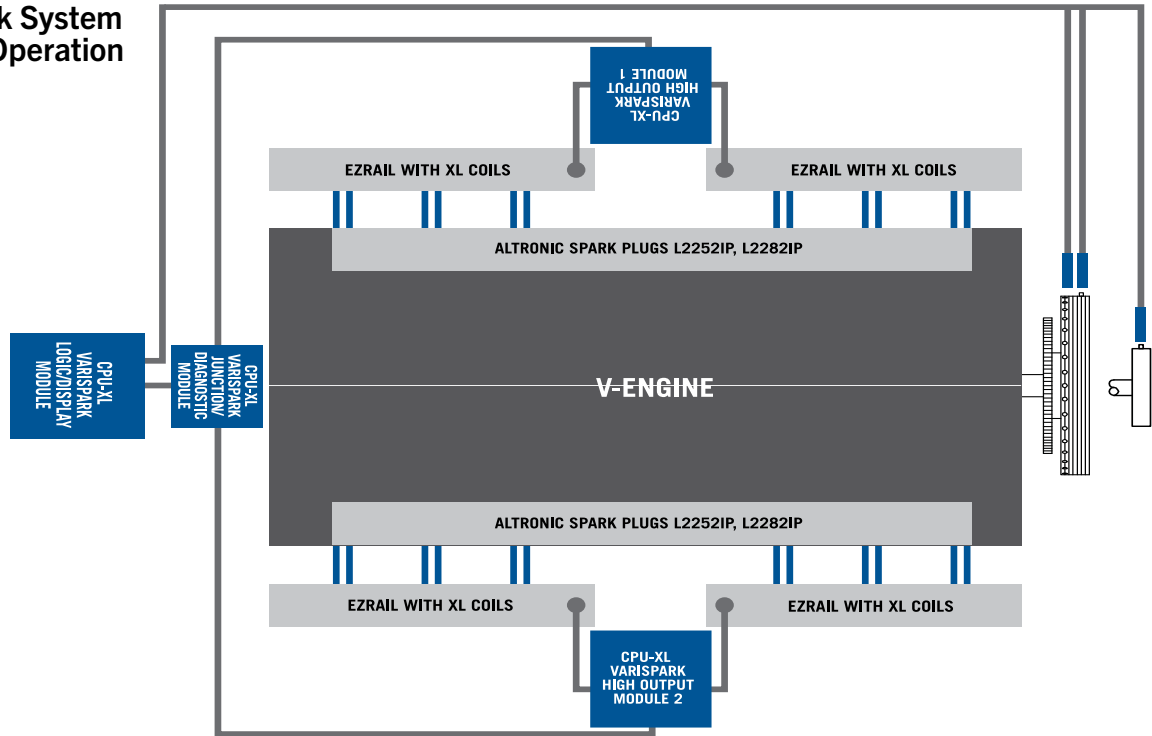

The CPU-XL VariSpark system consists of four modules:

Logic/Display Module – Typically mounted in the engine control panel, the Logic/Display Module includes the operator keypad and graphical display. It is the primary interface and manages all inputs, control, display, and communications functions. Its menu structure is similar to the CPU-2000 and CPU-95 systems.

Junction/Diagnostic Module – The Junction/Diagnostic Module replaces the traditional on-engine junction box in addition to housing all of the spark discharge diagnostic logic. All cylinder assignment for the engine firing order is accomplished in this module utilizing low-voltage wiring between pluggable connectors.

Output Module(s) – Connected by harness to the Junction/Diagnostic Module, an Output Module is installed on each bank of the engine. The function of this device is to accept logic-level firing signals and to generate the high energy electrical pulse (of the appropriate design as selected by the user for delivery to the Ignition Coil/EZRail Modules.

Ignition Coil/EZRail Module(s) – The CPU-XL VariSpark ignition coils and primary wiring are integrated into a series of engine-specific EZRail modules. These coil/rail modules are connected by harness to the Output Module and deliver a factory-certified and tested mounting and on-engine wiring solution. Primary cables and associated connectors are eliminated in the high-current portion of the system, thereby enhancing reliability.

Note: When incorporating an appropriate secondary lead and spark plug, the standard system is fully certified by CSA for use in Class I, Division 2, Group C and D hazardous areas.

The CPU-XL VariSpark determines the position of the engine crankshaft through the use of a magnetic pickup, sensing holes drilled into the flywheel or starting ring-gear teeth. This approach delivers a very accurate and reliable means of angular position indication and, when matched to the firing pattern and angles of the engine programmed within the system, allows for the delivery of the spark energy to each ignition output at precisely the right moment. A second flywheel-based pickup is used to generate a once-per revolution reset pulse. Four-cycle applications also utilize a Hall-effect pickup sensing a magnet turning at camshaft speed as a means of determining the compression cycle of the engine.

The timing and nature of the Directed Energy spark event delivered to each output is determined by the user and the application. All of the control information, including the timing adjustments and desired Directed Energy spark profile and characteristics directly influences the engine ignition timing and the voltage/current characteristics of the spark itself. Adjustments to both parameters can be made via the system keypad or via the Modbus RTU communication port resident within the Logic Module. Additionally, the engine ignition timing can be adjusted utilizing an external 4-20mA signal, an on-board RPM map, or through the Miscellaneous Input Switch.

A typical running message:



CPU-XL VariSpark Directed Energy Spark Profiles

Eight pre-configured spark profiles are embedded within the standard CPU-XL VariSpark system. While other profiles can be achieved, these eight have been selected as representative of those that have proven effective on the range of CPU-XL applications. Individual performance testing of each during the commissioning process will be required to determine which of these profiles deliver the most benefit to operation. All are configured to provide enhanced combustion assurance.

V = VOLTAGE
I = CURRENT

An expanded current spark profile. Unachievable with any other ignition system, this unique, specially-designed spark current profile features a high breakdown capability and the ability to enable movement of the spark along the spark plug ground electrode. The effect is minimized spark plug wear and improved performance, particularly on low emissions engines and on those 2- and 4-stroke cycle engines modified for enhanced combustion.

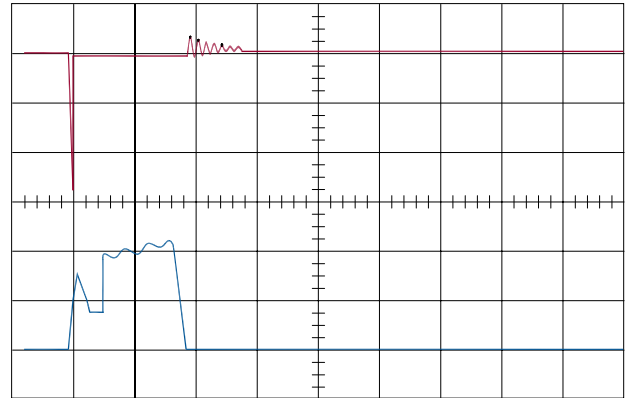

A rapid, multi-strike spark event consisting of five (5) distinct, CD-style spark discharges. This profile optimizes the advantages of a multi-strike approach as it maintains the desired peak pressure angle after top dead center (TDC). Doing so ensures optimum engine performance and has proven particularly beneficial on pre-combustion chamber-equipped engines.

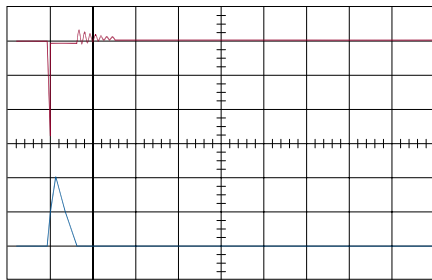
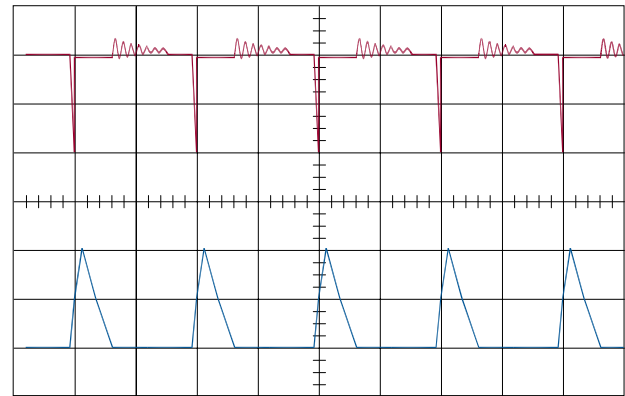

An enhanced, capacitive-discharge (CD) style spark profile.

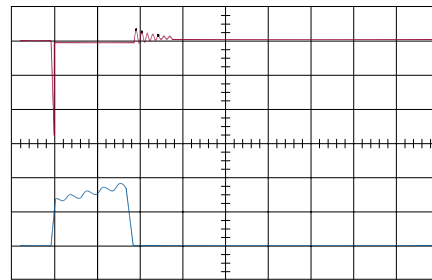

A long duration spark event featuring increasing current.

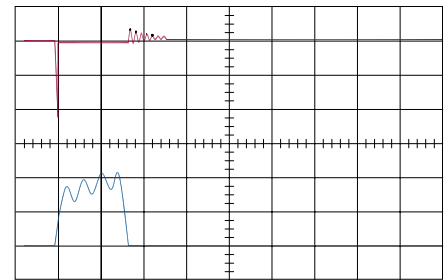

Similar in construction to the spark profile shown at left but incorporating lower duration.

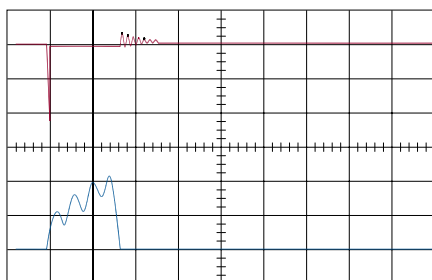

Profile features many of the same characteristics of the spark profile shown at right in the above row, but with lower applied energy.

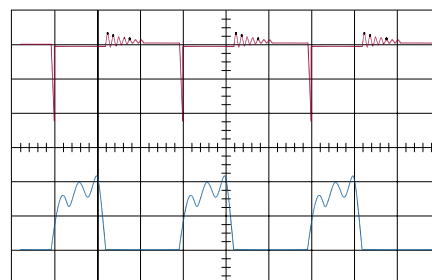

A multi-strike profile incorporating three (3) independent spark discharges with each featuring longer duration and increasing current.

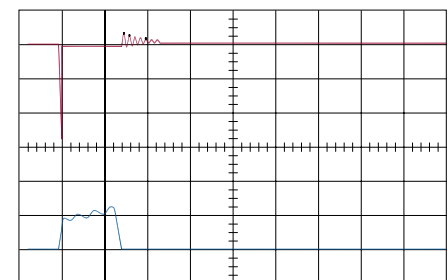

A long duration, lower-current spark profile that also offers maximized spark plug life.



CPU-XL VariSpark Diagnostics

To assist operators of gas engines in properly locating and diagnosing the source of ignition-related problems, a suite of comprehensive, easy-to-use, troubleshooting diagnostics have been developed and imbedded into the CPU-XL VariSpark system. The goal of these diagnostics is simple: reduce engine downtime and all of the costs associated with it.

CPU-XL VariSpark diagnostics are split into two separate groups. System diagnostics are those that relate primarily to the operation of the ignition system itself or to the inputs into the system (pickups, control inputs, etc.). The second group encompasses powerful spark discharge diagnostics. These powerful, non-intrusive diagnostics are unique in the industry for their reliability and the fact that they do not require any add-on probes or clamps, or any other special equipment. Instead, Altronic spark discharge diagnostics utilize the CPU-XL ignition coils in assessing secondary voltage demand. This valuable capability assists users in determining the proper point at which to change their spark plugs, in troubleshooting problematic primary and secondary connections, and in detecting combustion anomalies in the cylinder (such as air/fuel ratio or imbalance conditions). The diagnostic functions also assist the user selecting the appropriate point at which to manually or automatically adjust the spark profile to assure maximum spark plug life and reliable combustion.

Typical System Diagnostics

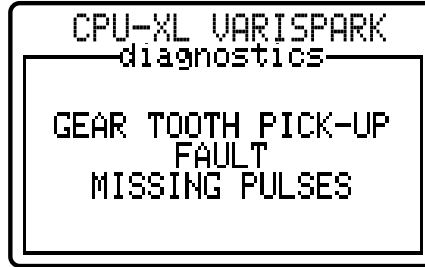

Zero gear-tooth pulses are seen between two reset pulses.



Too many gear-tooth pulses are seen without a reset pulse.

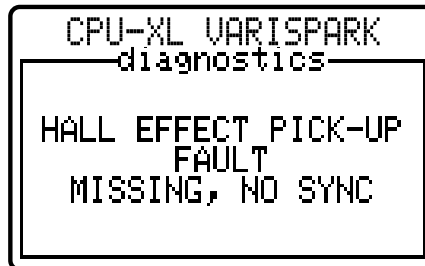

No Hall-effect pickup pulses, or the pickups are not synchronized.



Too many or too few gear tooth pulses are seen between reset pulses. The received number of pulses is displayed.

Typical Spark Discharge Diagnostics

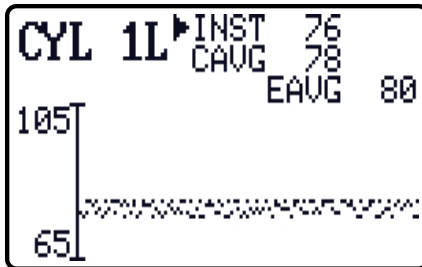

Spark diagnostics directly indicate breakdown voltage required. In this case, the cylinder average breakdown voltage (CAVG) required is 78, which indicates that the demand is 7.8kV

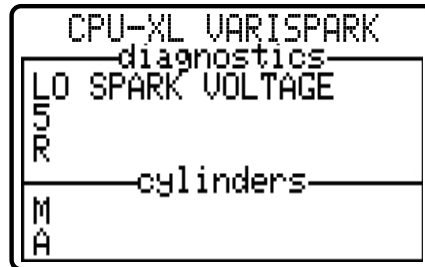

Low spark demand condition on cylinder 5R; often caused by a shorted spark plug or shorted secondary wire.

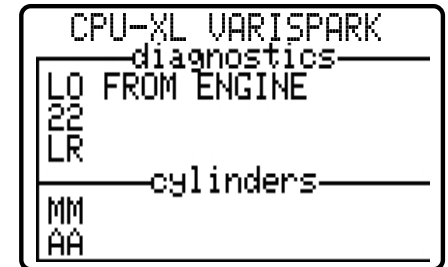

Condition detected where the average value of 2L and 2R is significantly lower than the average of other cylinders on the engine. HI FROM ENGINE diagnostic is also available.

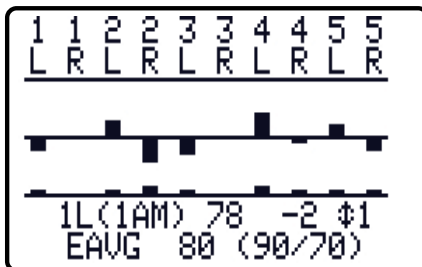

Enhanced display allows the user to monitor all cylinders simultaneously.

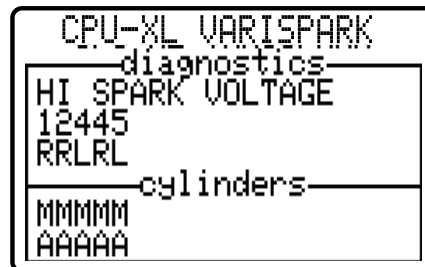

High spark demand condition on cylinders 1R, 2R, 4L, 4R, and 5L; often caused by worn spark plugs.

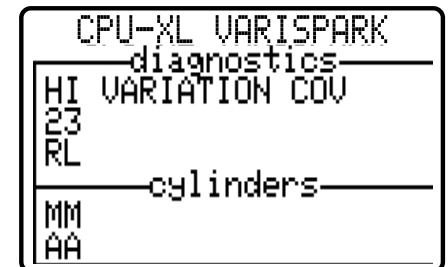

Outputs 2R and 3L are firing with significant cycle-to-cycle variation.

Specifications

INPUTS

Magnetic Pickups (2)

- 1 – flywheel holes or ring gear teeth
- 1 – reset (1/engine revolution)

Hall-effect pickup for compression stroke reference
(4-cycle applications only)

Timing Control Inputs

- Analog: 4–20mA control signal
- Digital:..... Modbus RTU, misc. input terminal
- Manual:..... Logic Module keypad

RS-485 serial and USB communications — ModBus RTU communications protocol supported

Spark Profile Control

- Automatic: High COV
- Analog: 4-20mA signal
- Digital:..... Modbus RTU
- Manual:..... Logic Module keypad

OUTPUTS

Up to 20 cylinders, 2 coils per cylinder

RS-485 serial communications — ModBus RTU communications protocol supported

Output characteristics

- Selectable spark duration 50-2500µsec
- Selectable multistrike..... Included

DISPLAY

Backlit, enhanced graphic display

POWER REQUIREMENTS

24Vdc, 10 to 30 Amps, current consumption varies by application

TEMPERATURE

- 40°F to +158°F
- 40°C to +70°C

Ordering Information

CPU-XL Logic/Display Module 291400–1

CPU-XL Output Module
10-output 291410–1

CPU-XL Junction/Diagnostic Module .. 291405–2

NOTE: All new installations must use the 291405-2 Junction/Diagnostic Module and the 791401-2 Coil. The -1 versions of these parts are for replacement applications only.

See CPU-XL VariSpark Application List for further details.

ALTRONIC

A Member of the HOERBIGER Group

712 Trumbull Avenue / Girard, Ohio 44420
(330) 545-9768 / Fax: (330) 545-9005
www.altronic-llc.com Email: sales@altronic-llc.com

FORM CPU-XL VariSpark 8-22 ©2022 Altronic, LLC

Logic/Display Module Dimensions

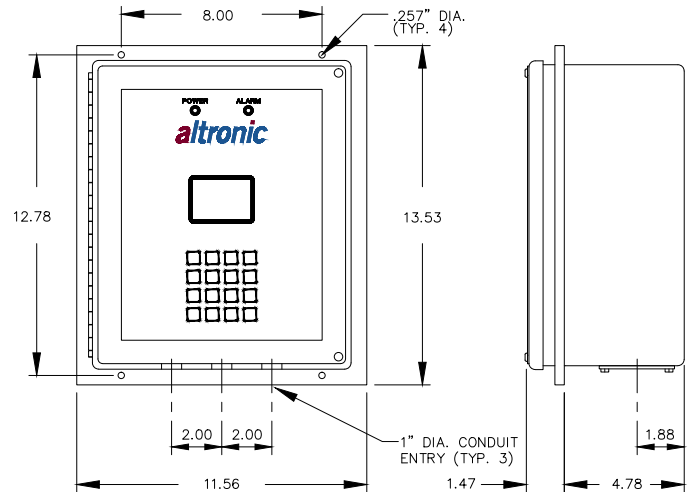

NOTE: PANEL CUT-OUT IS 10.12" X 12.12"
ALL DIMENSIONS ARE IN INCHES.

Output Module Dimensions

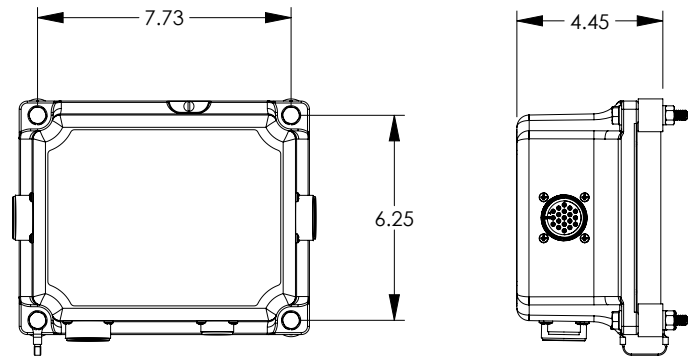

Junction/Diagnostic Module Dimensions

